

CUSTOMIZABLE Pro-Hygiene Solutions

When it comes to maximizing workplace health and safety for your staff and customers, every effort counts. Look to Nemco for smart, effective solutions that are easy to use and built commercial tough.



CUSTOMIZABLE Pro-Hygiene Solutions

Easy Shield™ Clear Partitions — Utility Line

NEW!

- Great for personal use and mobility—ideal for short-term applications, like classrooms and conference rooms.
- Portable, lightweight and easy to carry, even for a child.
- Unfold quickly to set up on a desk or table, then, fold flat again to store away.
- Material is PETG (polyethylene terephthalate glycol) —5 to 7 times stronger than acrylic.
- Optional: Surfaces can be frost coated to create a white-board effect.
- Rubber or plastic foot kits available—sold separately.

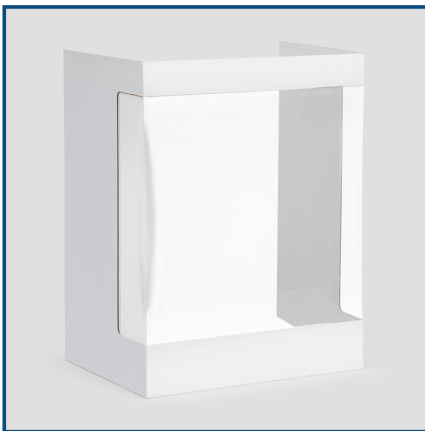

Corrugated Shield
#69989-20 20"W x 15"D x 27"H

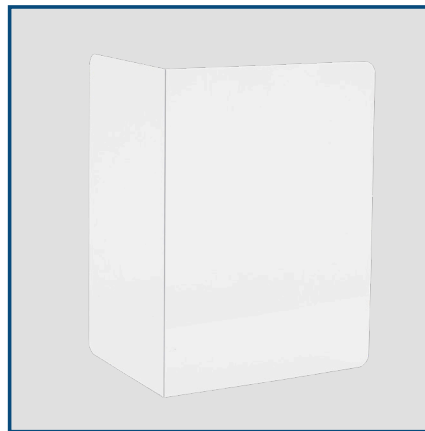

L Shield—.060" PETG
#69994-10 18"W x 14"D x 24"H

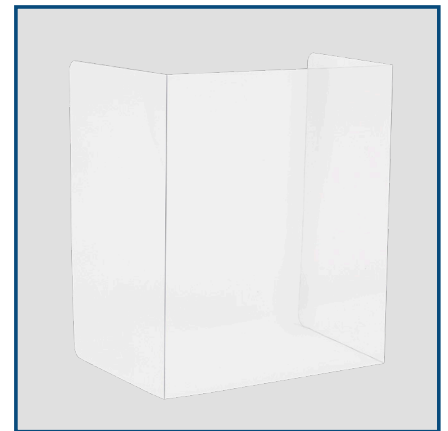

U Shield—.060" PETG
#69996-10 20"W x 14"D x 24"H

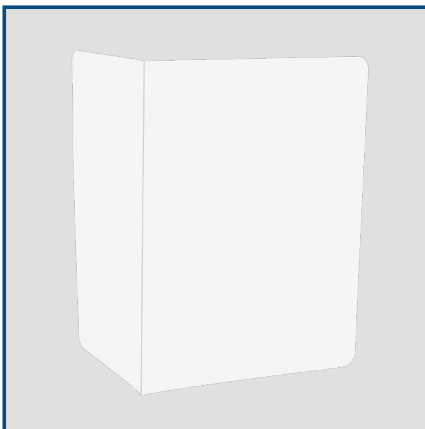

L-Bend Shield—.040" PETG
#70004 18"W x 14"D x 24"H

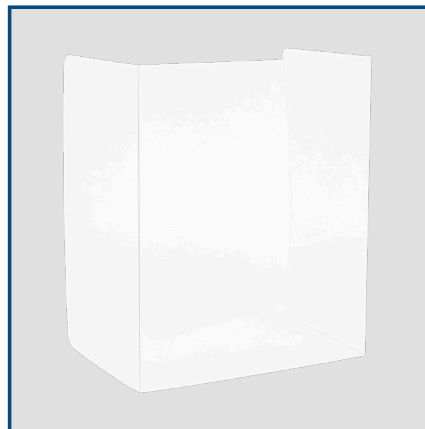

U-Bend Shield—.040" PETG
#70006 20"W x 14"D x 24"H

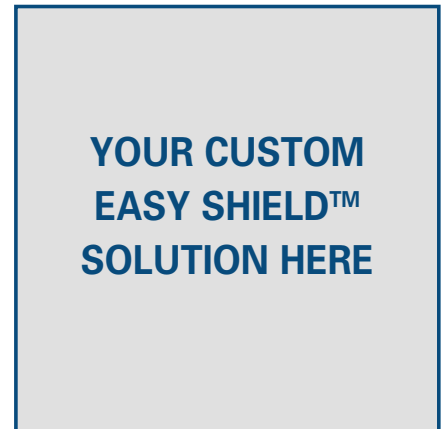

Accessory Foot Kits for L & U Shields
Black Rubber Foot Kit, (6)
#69992-6

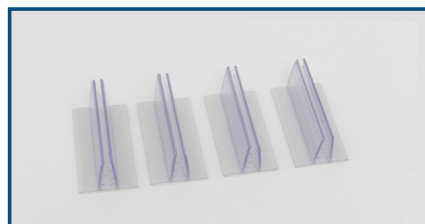

Accessory Foot Kits for L & U Shields
Plastic Track w/ double-sided Tape (4)
#69990-4

CUSTOMIZABLE Pro-Hygiene Solutions

Easy Shield™ Clear Partitions

Polycarbonate for Maximum Durability!

Custom Logo Etching Available

nemco | FOOD EQUIPMENT

- Improve health-safety at point-of-sale or other face-to-face interactions.
- Made from durable, easy-to-clean polycarbonate.
- Scratch-resistant to preserve a clear, face-to-face-friendly barrier.
- Easy Shield meets all North American building fire codes
- **24 hour shipping on all in-stock shields**

Available Leg Colors

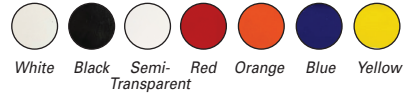

Available Shield Colors

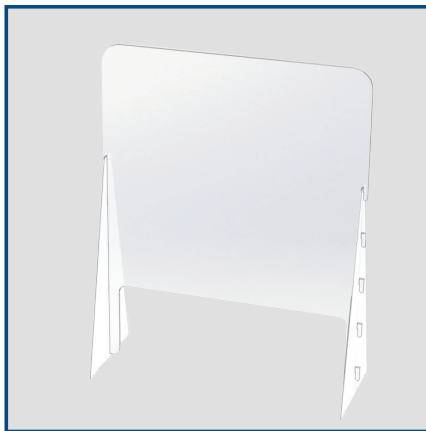

**Countertop Easy Shield™
With 10" Legs #69804**
34"W x 14"D x 42"H



Easy Shield™ 24" Wide #69792-24
24"W x 12"D x 42"H



Easy Shield™ 36" Wide #69792-36
36"W x 12"D x 42"H



**Countertop Easy Shield™
With Pass-Thru #69826-32**
32"W x 13 7/8"D x 24 5/8"H



Hanging Easy Shield™ #69798
Hanging Cable Attached
36"W x 1/8"D x 24"H

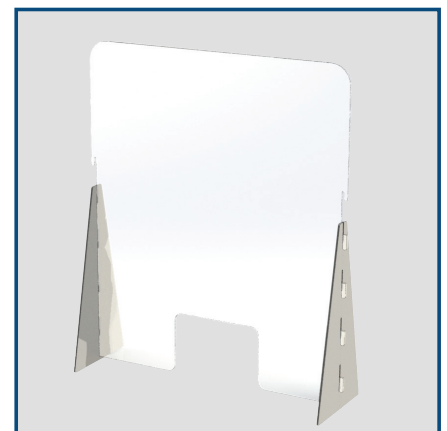

**Countertop Easy Shield™
With White Legs**

CUSTOMIZABLE Pro-Hygiene Solutions

Polycarbonate for
Maximum Durability!

Easy Shield™ Clear Partitions



School Desk Shields #69959
17"W x 17"D x 22"H

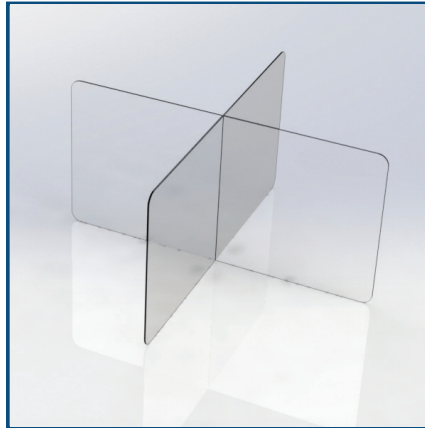

Easy Shield™ 4-Way Tabletop Partitions

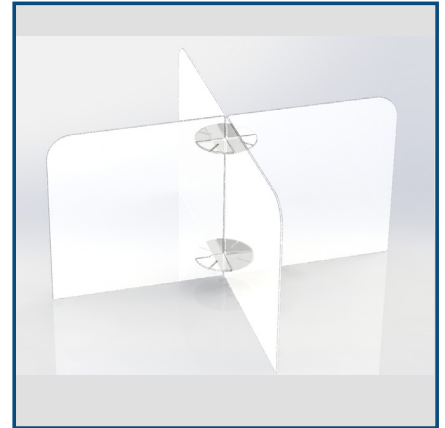

Easy Shield™ Core Shield w/ slots for versatile partition arrangement



Wall-Mounted Easy Shield™

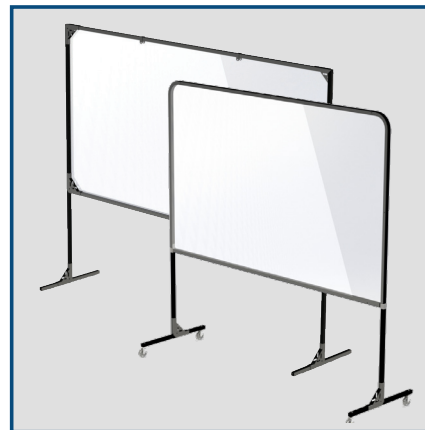

Framed Easy Shield™ Available With Or Without Casters



Framed Easy Shield™ #69914 Available With Or Without Casters
42"W x 24"D x 84"H

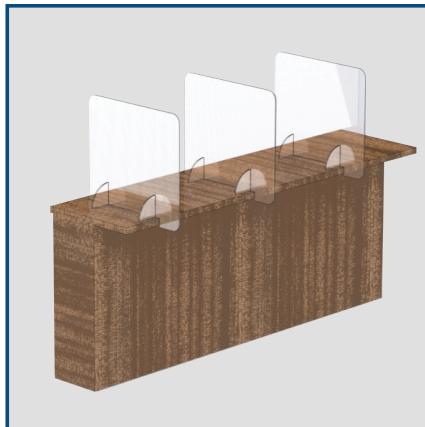

Bar Divider Easy Shield™—Movable #69931-24-30

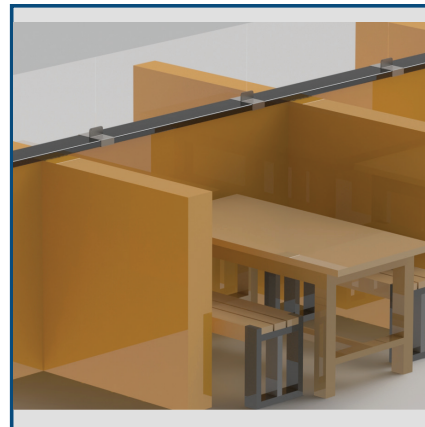

Booth Divider Easy Shield™

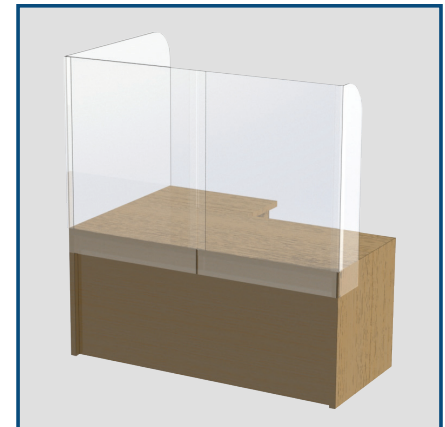

Desk Easy Shield™

CUSTOMIZABLE Pro-Hygiene Solutions

Polycarbonate for
Maximum Durability!

Easy Shield™ Clear Partitions



Receptionist Kiosk Easy Shield™

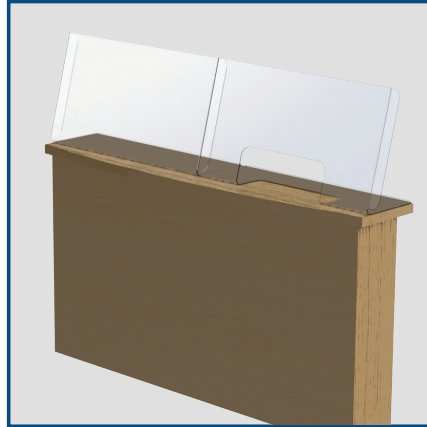

**Receptionist Kiosk Easy Shield™
Flange Mounted**



**Receptionist Kiosk Easy Shield™
Single No Pass-Thru**

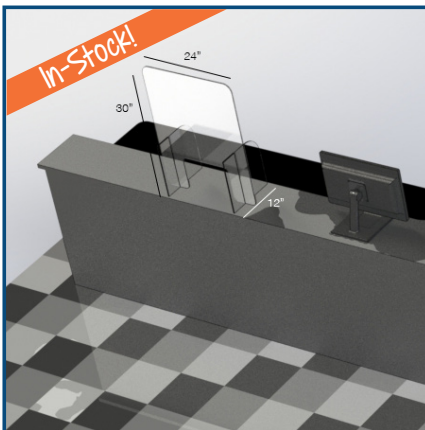

**Easy Shield, Countertop, Pass-Thru
#69885-24-30-P-06 w/ 12" low-profile deep
legs for more operator-side workspace**

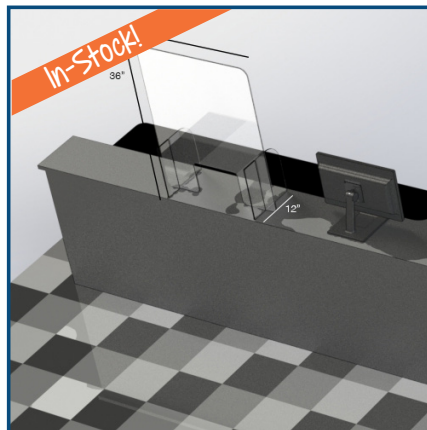

**Easy Shield, Countertop, Pass-Thru
#69885-30-36-P-09 w/ 12" low-profile
deep legs more operator-side workspace**

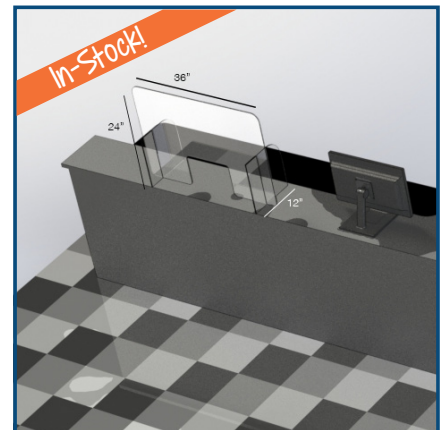

**Easy Shield, Countertop, Pass-Thru
#69885-36-24-P-12 w/ 12" low-profile
deep legs more operator-side workspace**

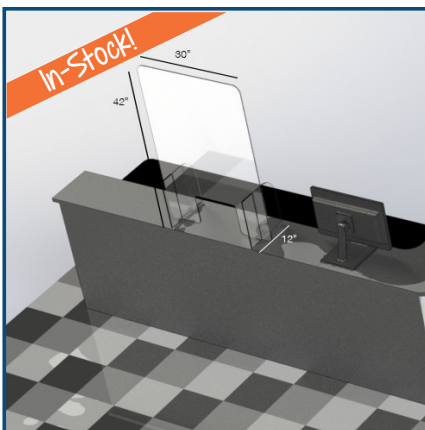

**Easy Shield, Countertop, Pass-Thru
#69885-30-42-P-09 w/ 12" low-profile
deep legs for more operator-side workspace**



**Easy Shield, Countertop, No Pass-Thru
#69884-30-36-P w/ 12" low-profile deep
legs more operator-side workspace**



**Easy Shield, Countertop, No Pass-Thru
#69884-36-36-P w/ 12" low-profile deep legs
more operator-side workspace**

CUSTOMIZABLE Pro-Hygiene Solutions

nemco® | FOOD EQUIPMENT

Polycarbonate for Maximum Durability!

Easy Shield™ Clear Partitions

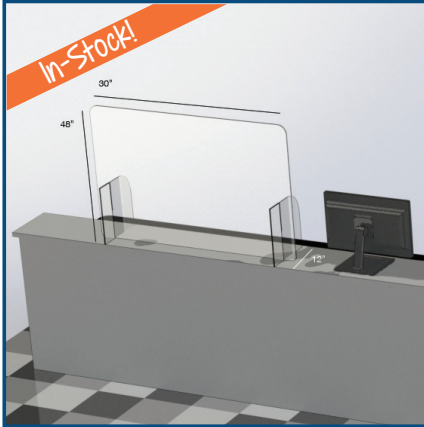

Easy Shield, Countertop, Pass-Thru #69884-48-30-P w/ 12" low-profile deep legs for more operator-side workspace



Easy Shield, Hanging #69886-48-24-P



Easy Shield, Hanging #69886-48-36-P



Receptionist Kiosk Easy Shield™ Single Pass-Thru

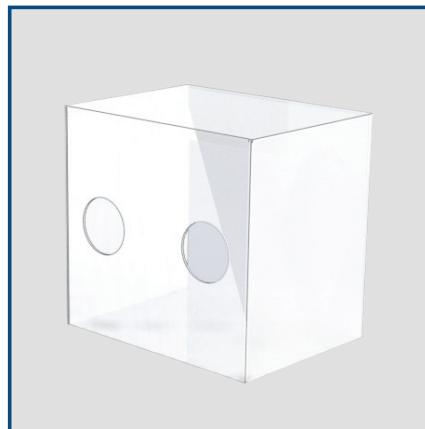

Intubation Box



Sloped Top 24 Easy Shield™



Sloped Top 30 Easy Shield™



Sloped Top 48 Easy Shield™



Sloped Top 60 Easy Shield™

CUSTOMIZABLE Pro-Hygiene Solutions

nemco® | FOOD
EQUIPMENT

Easy Shield™ Clear Partitions

Polycarbonate for
Maximum Durability!

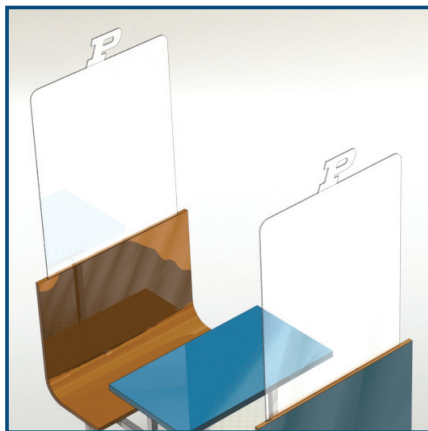

*Your Logo Easy Shield™
On Booth*

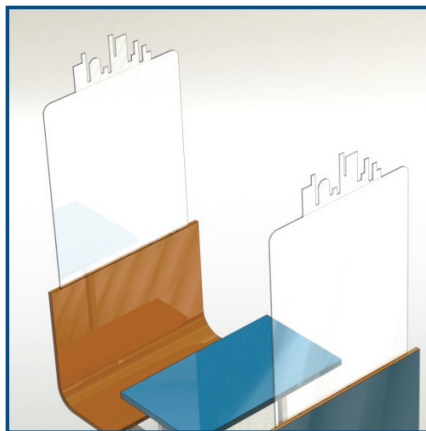

*Cityscape Easy Shield™
On Booth*

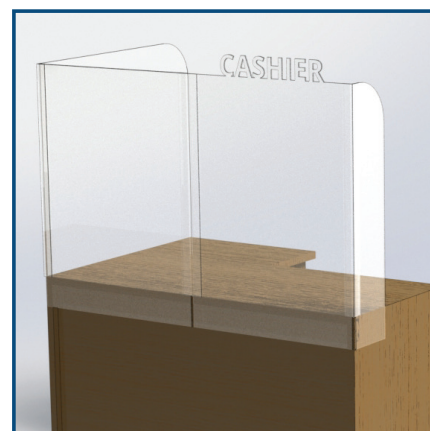

Cashier Easy Shield™ On Counter

CUSTOMIZABLE Pro-Hygiene Solutions

Other Easy Shield™ Solutions



Easy Shield™ Face Shield
#69925-10 12"W x 1 1/2"D x 8 3/4"H
Comes in packs of 10 or 200. Material is
APET (amorphous polyethylene terephthalate)
***Not intended for medical use**



Easy Shield™ Face Shield (child size)
#69925-10-S 10 1/4"W x 1 1/2"D x 8"H
Comes in packs of 10 or 200. Material is
APET (amorphous polyethylene terephthalate)
***Not intended for medical use**

**YOUR CUSTOM
EASY SHIELD™
SOLUTION HERE**

CUSTOMIZABLE Pro-Hygiene Solutions

Clean Getaway™ & Other Hands-Free Door Openers

- Pull doors open without touching handles or other germ-covered surfaces.
- Stainless-steel for lasting strength and appearance.
- Versatile—can be placed almost anywhere.
- Easy to install; hardware included.



Protective Color Coating Available



Clean Getaway™ Forearm Model #69811 1 3/4"W x 3"D x 2 5/8"H



Clean Getaway™ Foot Model #69813 3"W x 2 3/4"D x 2 5/8"H



Clean Getaway™ for Cooler/Freezer Door Handle #69890 #69890-B
2 1/4"W x 3"D x 1 3/4"H



Clean Getaway™ for Full-Length Extruded Cooler Door Handle #69930; #69930-B
2 1/4"W x 3"D x 1 3/4"H



Kick plate Door Opener #69878
34"W x 12"H



Push plate Door Opener #69879
4"W x 16"H

CUSTOMIZABLE
Pro-Hygiene Solutions

Clean Getaway™ & Other Hands-Free Door Openers



**No-Touch Door Opener/Pro-Hygiene
MultiTool #69900-50**
1/4"W x 2 3/4"D x 1 1/2"H

**YOUR CUSTOM
CLEAN GETAWAY™
HERE**

**YOUR CUSTOM
CLEAN GETAWAY™
HERE**

CUSTOMIZABLE Pro-Hygiene Solutions

HyGenie™ Hands-Free Sanitizer Dispensers

- Pump levers designed to dispense using your forearm.
- Lightweight yet durable plastic construction
- Easy to set up where needed most.
- Customizable graphics available.



HyGenie™ Countertop Model
#10950-1 Black/Black
#10951-1 Black/White
 6 1/2"W x 13"D x 14 1/2"H

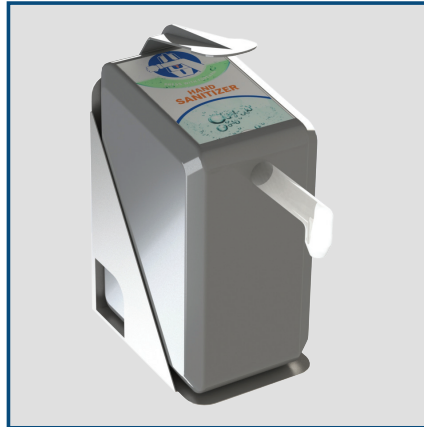

HyGenie™ Wall-Mounted Holder
HyGenie Sold Separately
#69945 (stainless), #69945-B, #69945-W
 6 3/4"W x 12"D x 12"H

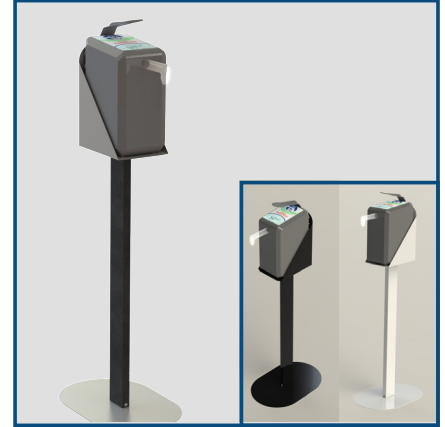

The HyGenie™ Freestanding Holder
HyGenie Sold Separately
#69940 (stainless), #69940-B, #69940-W
 12"W x 18"D x 47 1/2"H

**YOUR CUSTOM
SANITIZING
SYSTEM HERE**

CUSTOMIZABLE Pro-Hygiene Solutions

Other Hand-Washing and Sanitizing Systems

- Promote the most effective practice of preventing the spread of germs
- Solutions available for a range of unique applications
- All designed for lasting durability and user-friendliness



**Portable Hand-Sanitizer Pump
Dispenser #10978**
4"W x 6 3/4"H

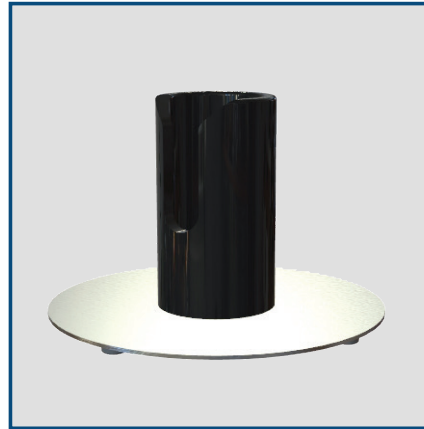

**Single Holder #10981
for Portable Hand-Sanitizer Pump
Dispenser** 5"W x 5"D x 3 3/4"H



**Double Holder #10982
For Portable Hand-Sanitizer Pump
Dispenser (Not Included)**
9"W x 5"D x 3 3/4"H



**Triple Holder #10983
For Portable Hand-Sanitizer Pump
Dispenser (Not Included)**
13"W x 5"D x 3 3/4"H



Portable Sink, 12 gallon #69960
27 1/2"W x 15"D x 52 3/4"H



Portable Sink, 30 gallon #69961
17 1/2"W x 31 1/2"D x 50"H

CUSTOMIZABLE Pro-Hygiene Solutions

Food-Safety Products

- Sanitary-positive barriers safeguard food from airborne droplets and aerosols.
- Delivery Caddy streamlines takeout process; keeps all order-components organized.
- Curb-side order station makes taking orders easy.
- Made from durable, high-quality materials.

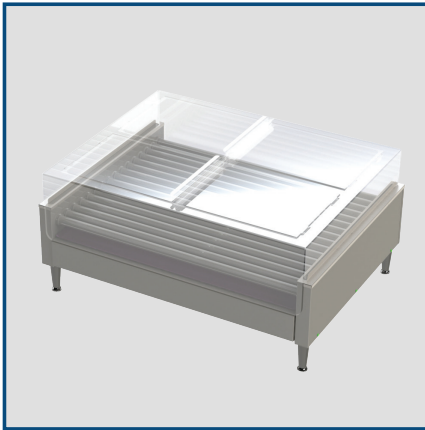

Roller Grill Low-Height Guard

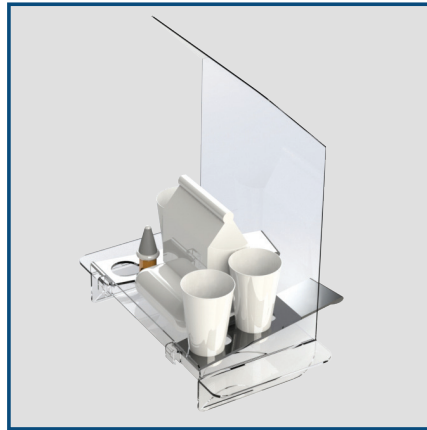

Curb-Side Delivery Caddy



*Curb-Side Order Station
includes fabric shoulder strap*

**YOUR CUSTOM
FOOD-SAFETY
PRODUCT HERE**

CUSTOMIZABLE Pro-Hygiene Solutions

Hygiene Stations

- Keep your sanitation products organized and easy to find.
- Stainless-steel construction for lasting strength and appearance.
- Wall-mount or free-standing models available.

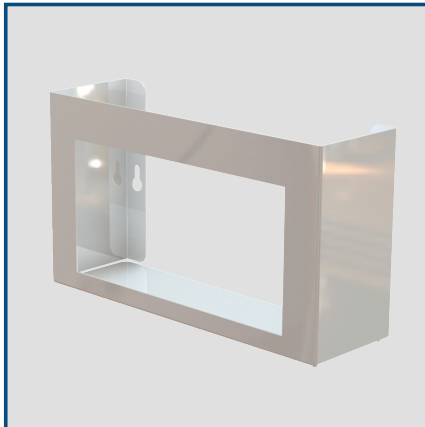

**Hygiene Station for Gloves—
Wall Mount #69910**
9 1/8"W x 3 1/8"D x 5"H

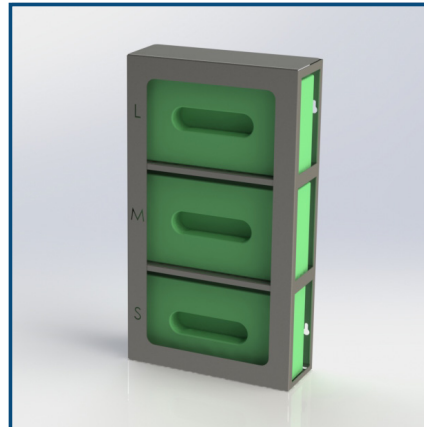

**Hygiene Station for Gloves—
Wall Mount #69910-3**
10 1/4"W x 3 5/8"D x 18 1/4"H

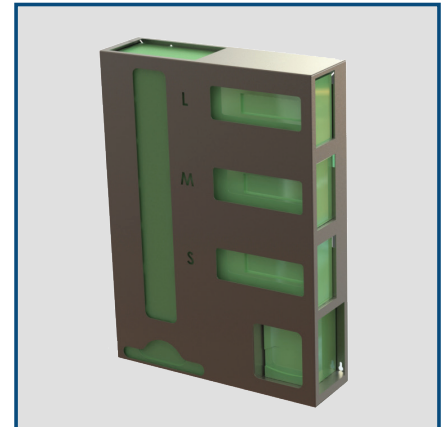

**Hygiene Station for Masks, Gloves
& Hair Nets—Wall Mount #69915**
18 1/8"W x 5 1/8"D x 25 1/8"H

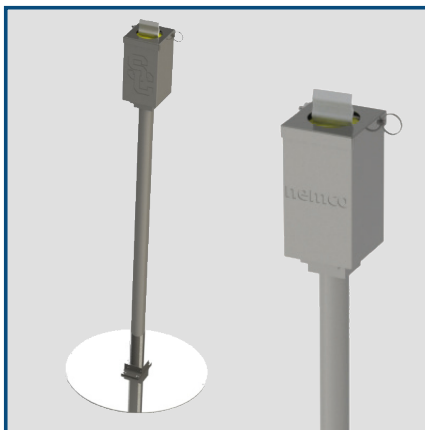

**Hygiene Station for Disinfectant
Wipes—Floor Model #69955**
15"W x 15"D x 39 1/4"H

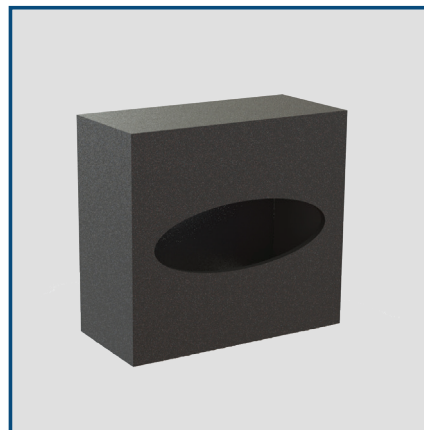

Bakery Paper Station

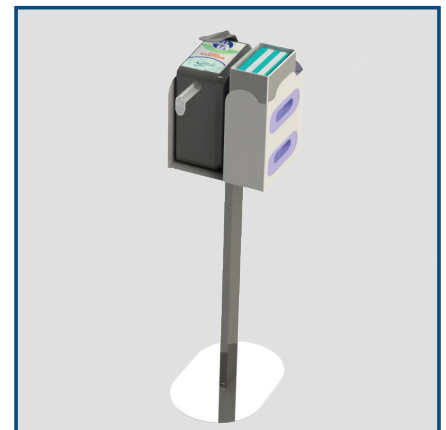

Hotel Stand