



Project _____

Item _____ Quantity _____

Approved by _____ Date _____

AIA/SIS # _____



TRAC 878

Triple Tank Tray Washer with Pre-Wash



878

Trays Per Hour



CrossFire™ Wash System



Made in the USA

SPECIFIER STATEMENT

Specified unit will be a TRAC 878 triple tank tray washer with recirculating pre-wash, wash, and rinse systems and fresh water final rinse. Features include color-coded curtains, CrossFire wash system, top-mounted NEMA 12 control panel, automatic tank fill, and capillary thermometers for wash and rinse. Includes a 1-year parts and labor warranty.

STANDARD FEATURES

- Washes 878 trays (15") per hour
- ColorCorrect curtains
- CrossFire™ wash system cleans tray surfaces from top, bottom and sides
- Recirculating pre-wash tank
- Top-mounted NEMA 12 control panel
- TRAC series is the only NSF® approved tray washing solution
- Automatic tank fill
- Capillary thermometers for wash and rinse
- Detergent connection provision
- Door safety switch
- End caps/pipe plugs secured to prevent loss
- In-line thermometer for final rinse
- Inspection door
- Left or right hand configuration
- Low water protection
- Manifold clean-out brush
- Override switch for de-liming
- Simplified scrap screen design
- Single point electrical connection: motor, controls and tank heat (Booster requires a separate connection)
- Standard frame drip proof motors
- Tray unload table
- Vacuum breaker on all incoming water lines
- Vents with adjustable damper controls

OPTIONS & ACCESSORIES

- Chemical sanitizer injector package for low temperature operations (dispenser by others)
- Electric booster
- Insulated hood and door
- Pressure regulating valve and line strainer
- Security package
- Stainless steel steam coil tank heat
- Steam booster
- Tray Dryer
- Tray Stacker

TECHNICAL INFORMATION

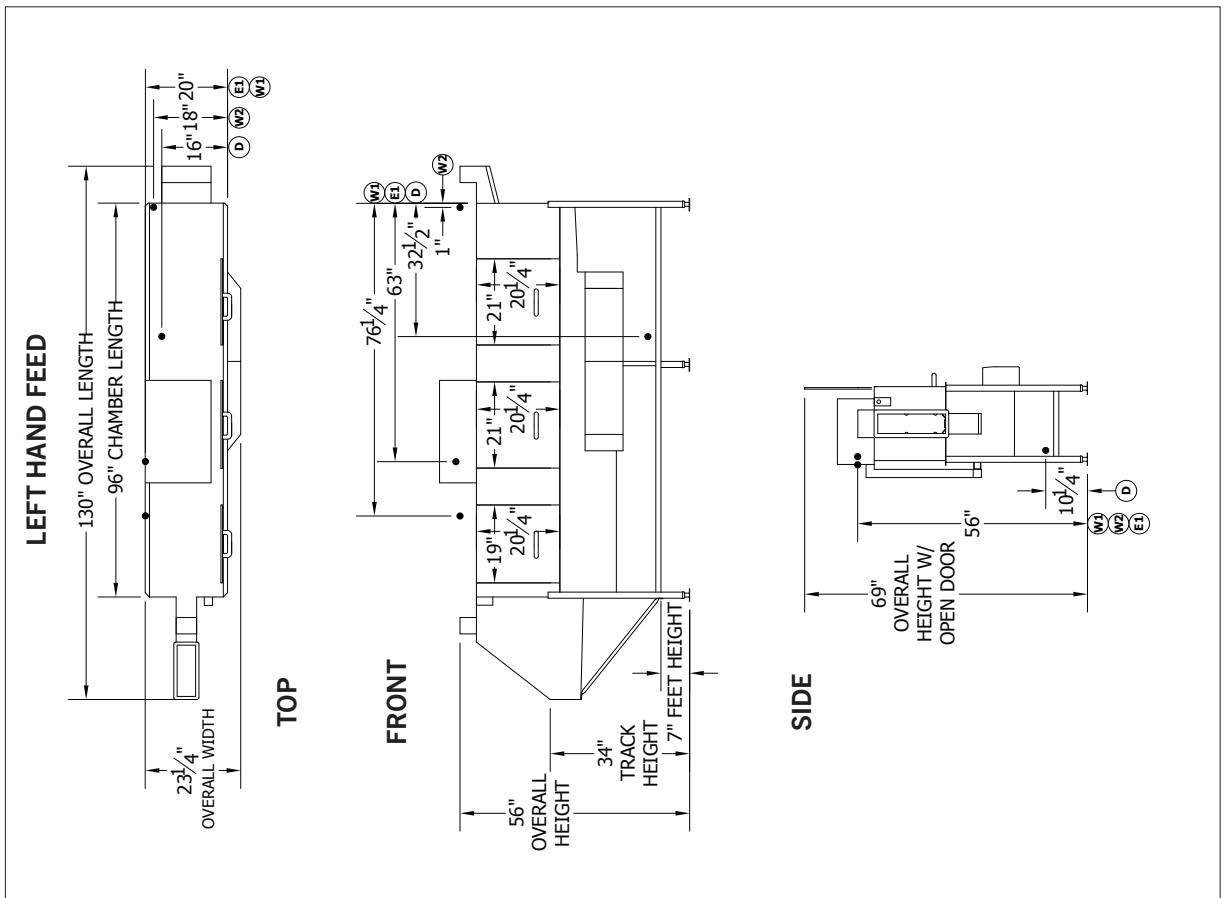
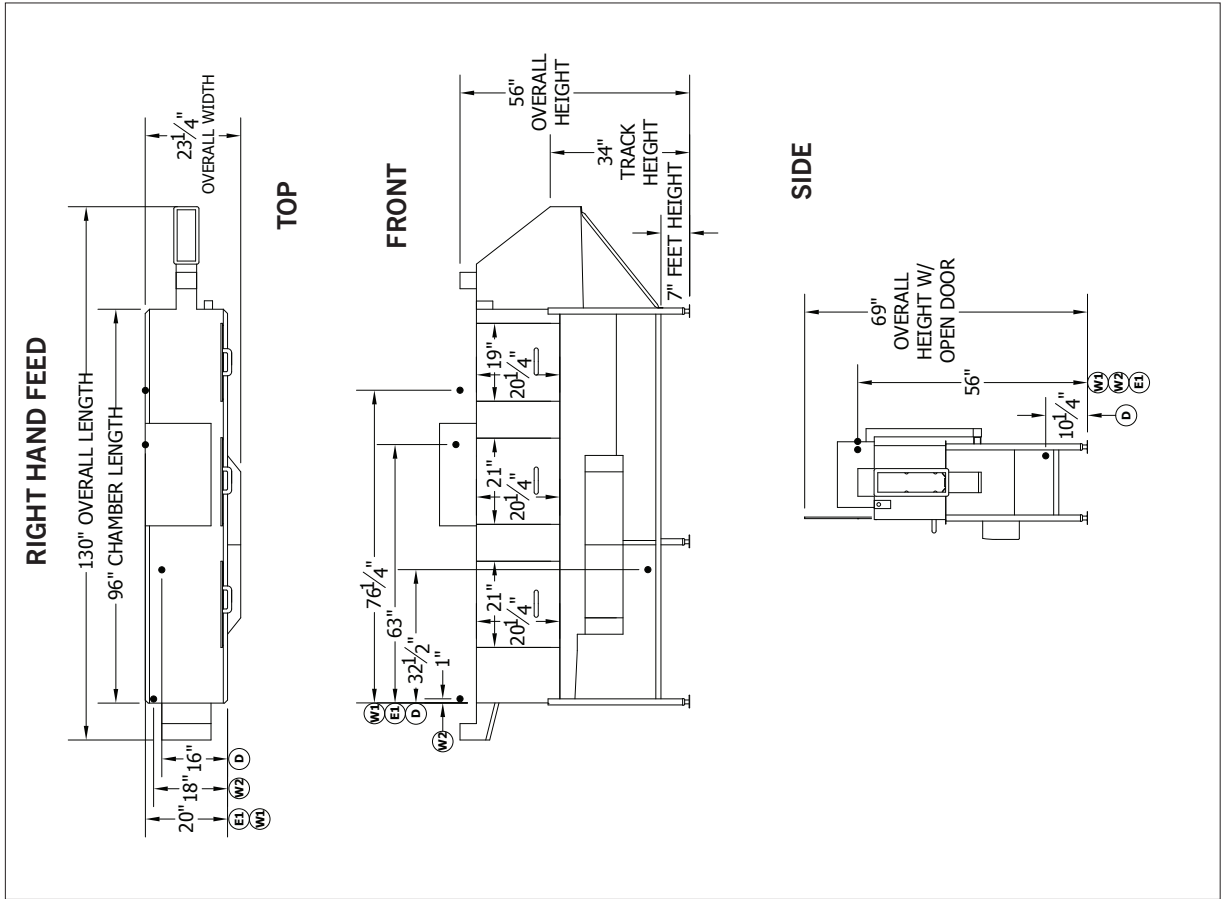

TECHNICAL INFORMATION

RIGHT HAND FEED WITH UNLOAD TABLE, STEAM BOOSTER, AND OPTIONAL TRAY DRYER

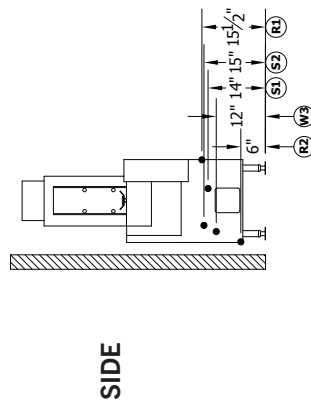
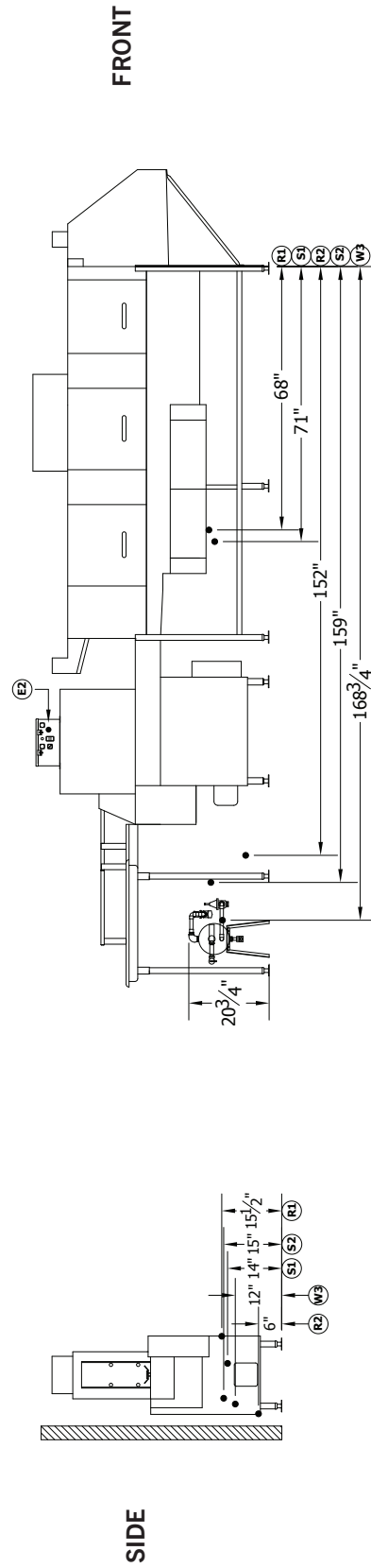
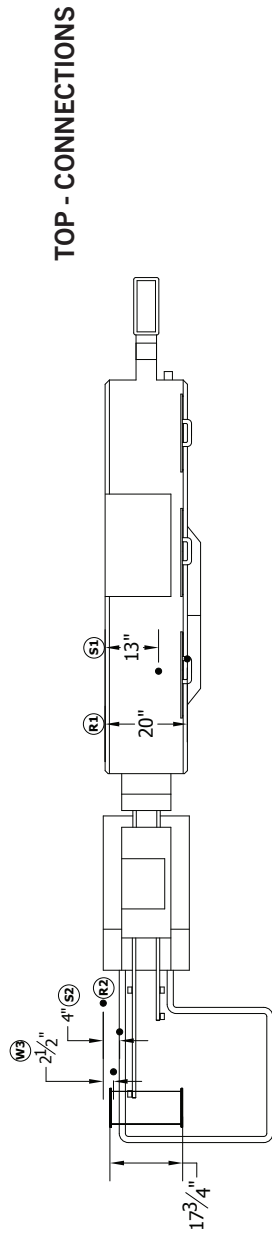
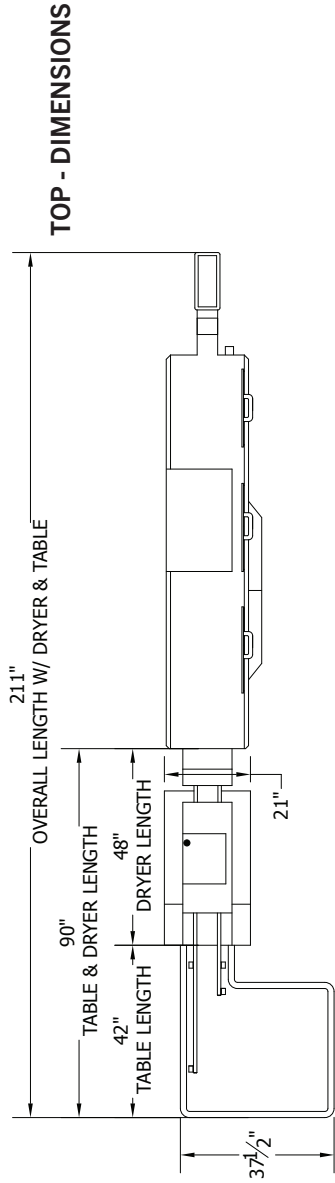

TECHNICAL INFORMATION

LEFT HAND FEED WITH UNLOAD TABLE, STEAM BOOSTER, AND OPTIONAL TRAY DRYER

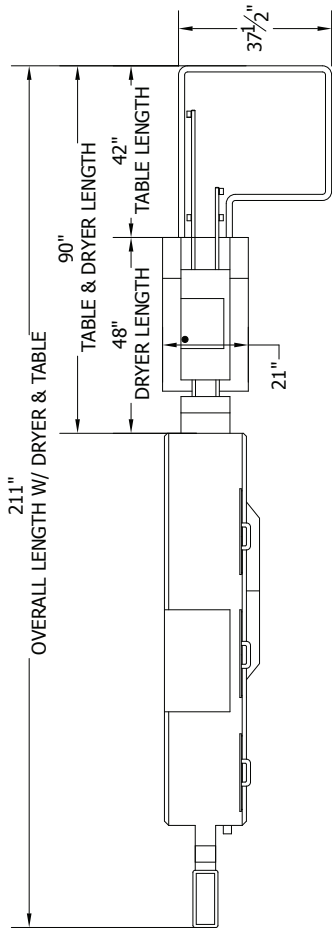

TOP - DIMENSIONS

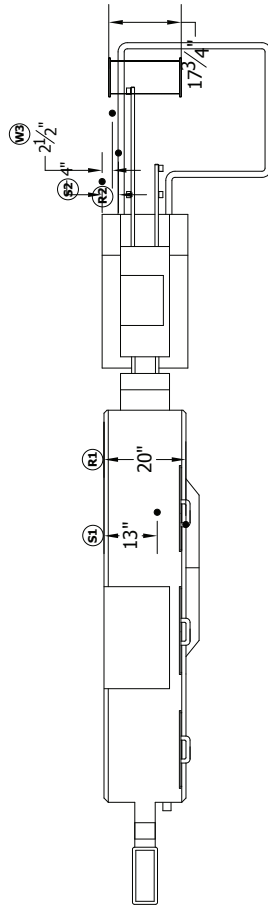

TOP - CONNECTIONS

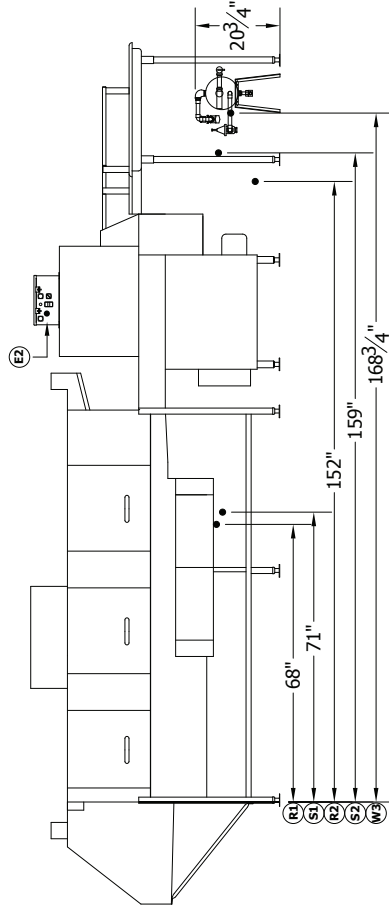

FRONT

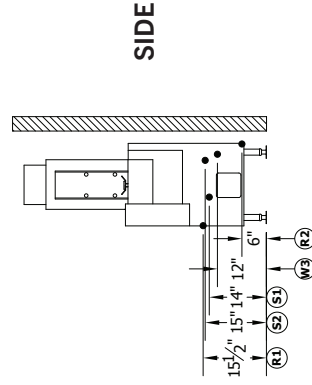

SIDE

TECHNICAL INFORMATION

RIGHT HAND FEED WITH UNLOAD TABLE, ELECTRIC BOOSTER, AND OPTIONAL TRAY DRYER

TOP

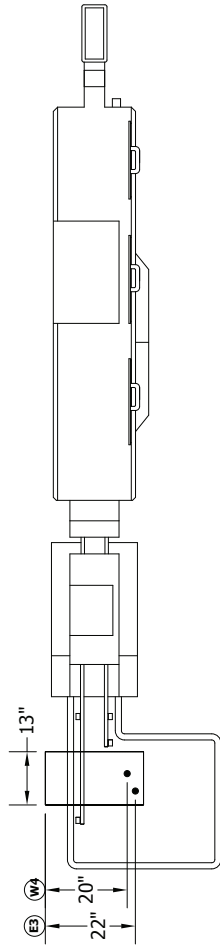

FRONT

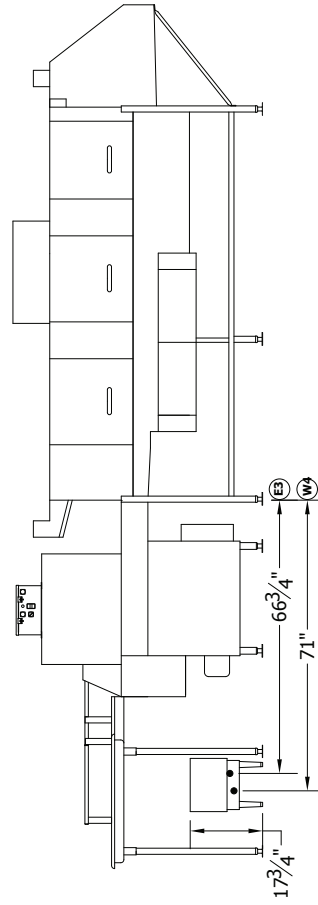

SIDE

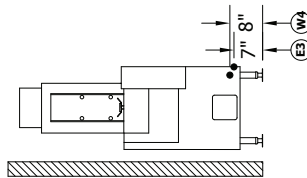

TECHNICAL INFORMATION

LEFT HAND FEED WITH UNLOAD TABLE, ELECTRIC BOOSTER, AND OPTIONAL TRAY DRYER

TOP

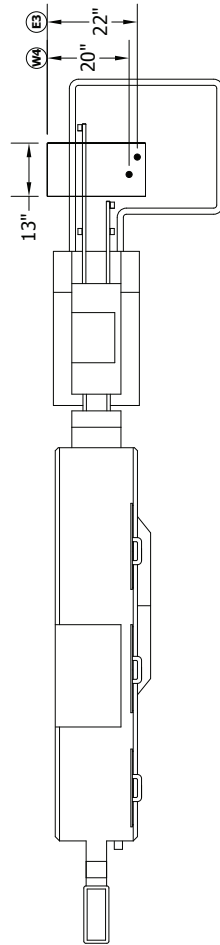

FRONT

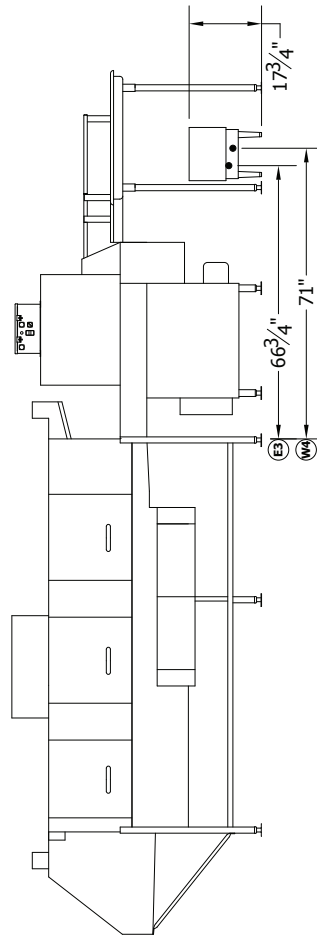

SIDE

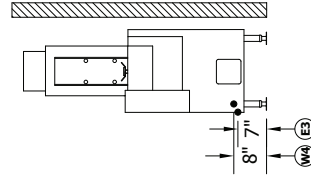

TECHNICAL INFORMATION

RIGHT HAND FEED WITH UNLOAD TABLE AND STEAM BOOSTER

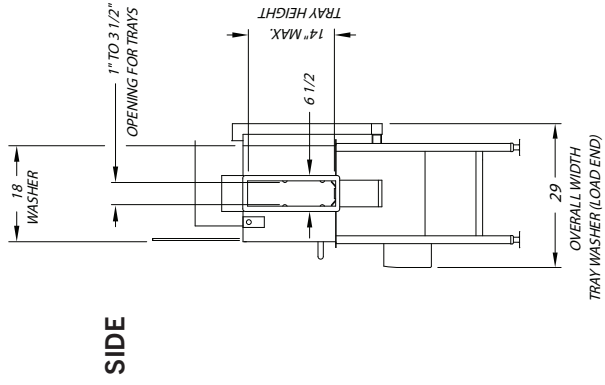
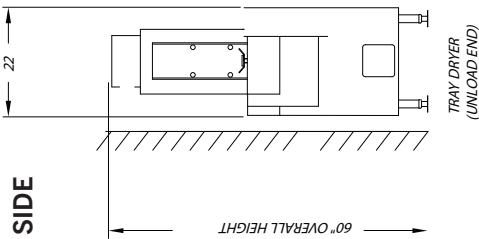
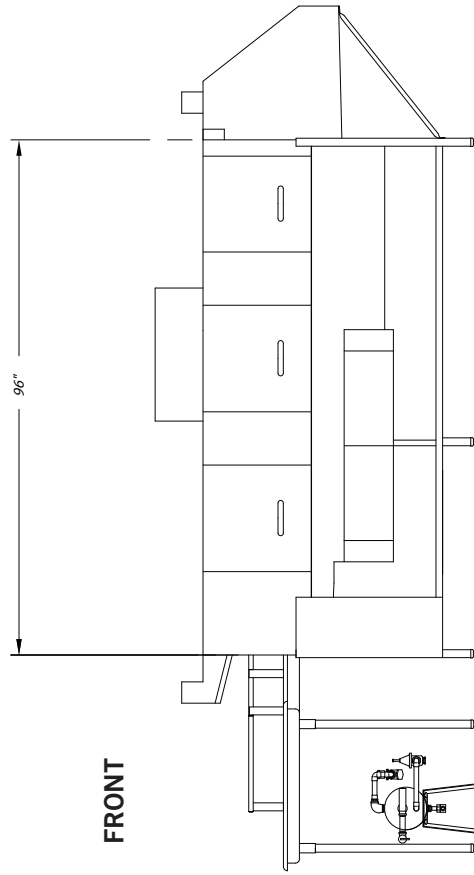
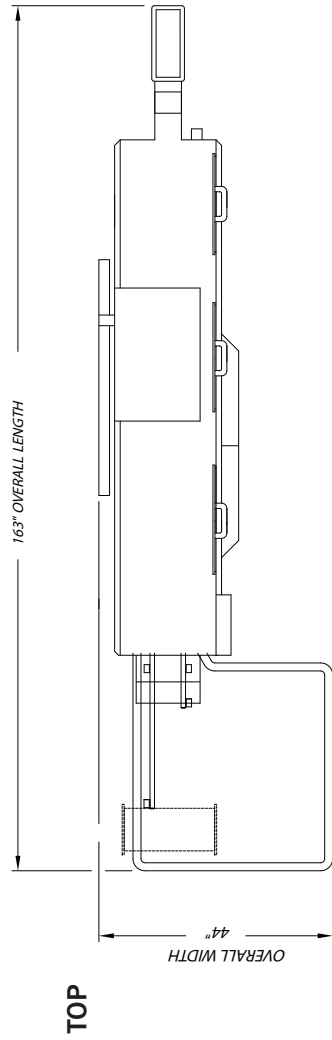

TECHNICAL INFORMATION

LEFT HAND FEED WITH UNLOAD TABLE AND STEAM BOOSTER

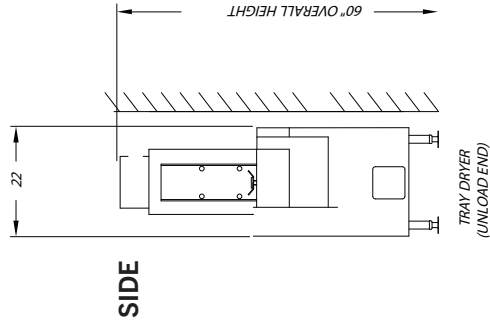
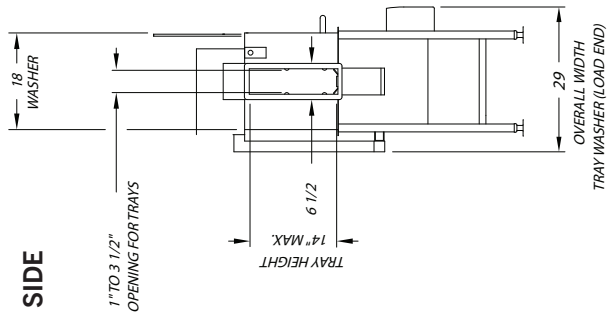
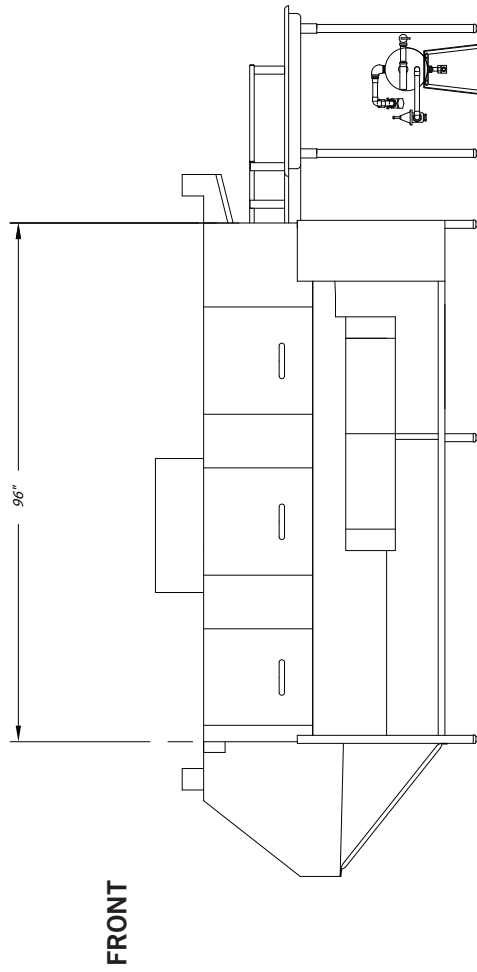
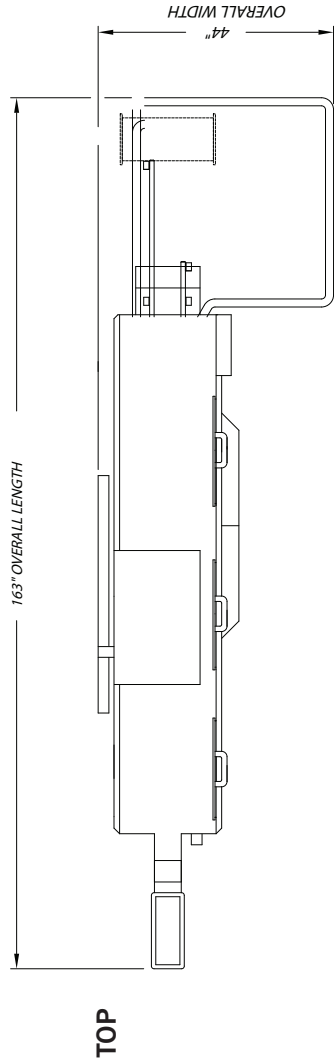

TECHNICAL INFORMATION

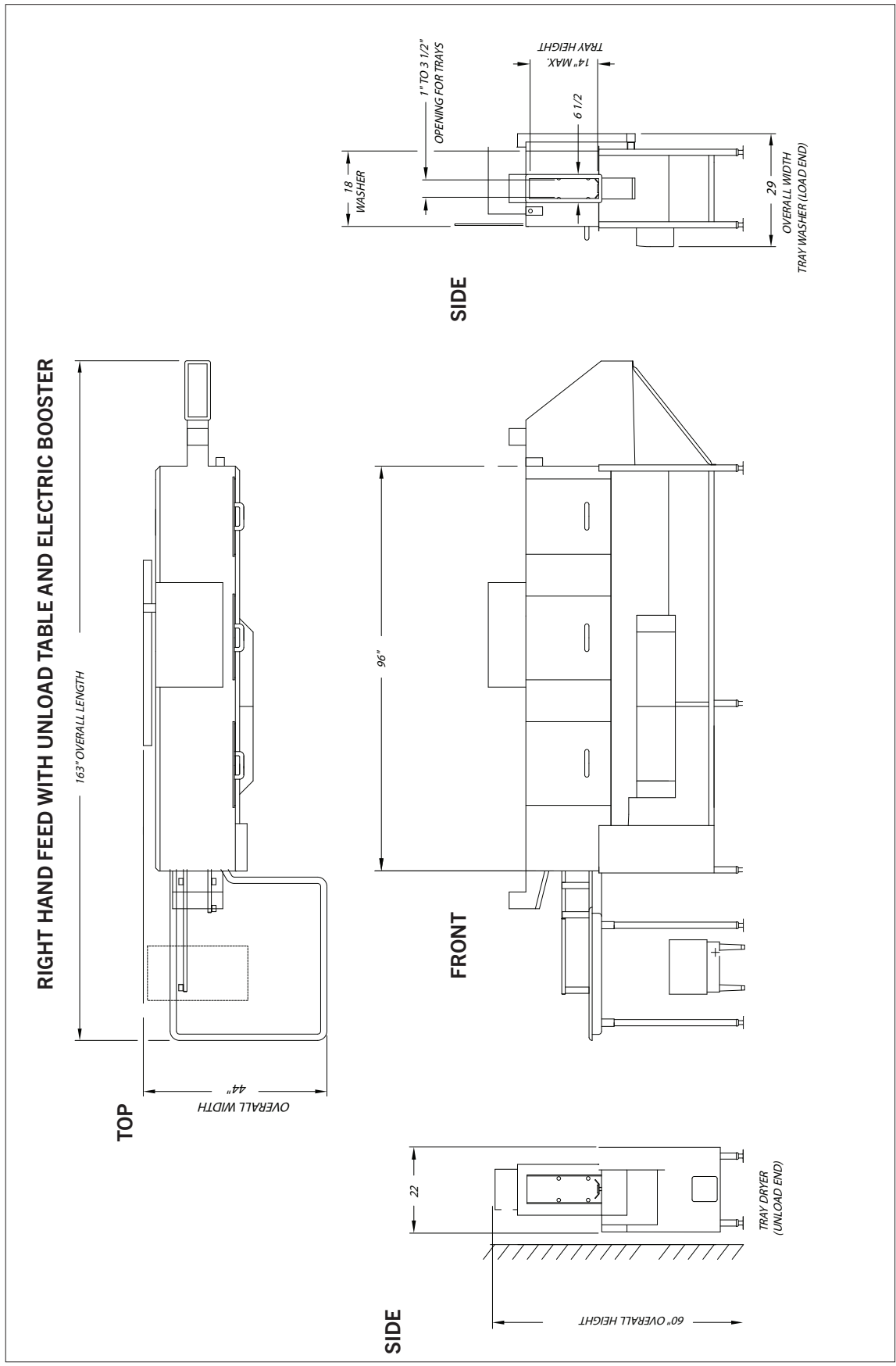

TECHNICAL INFORMATION

LEFT HAND FEED WITH UNLOAD TABLE AND ELECTRIC BOOSTER

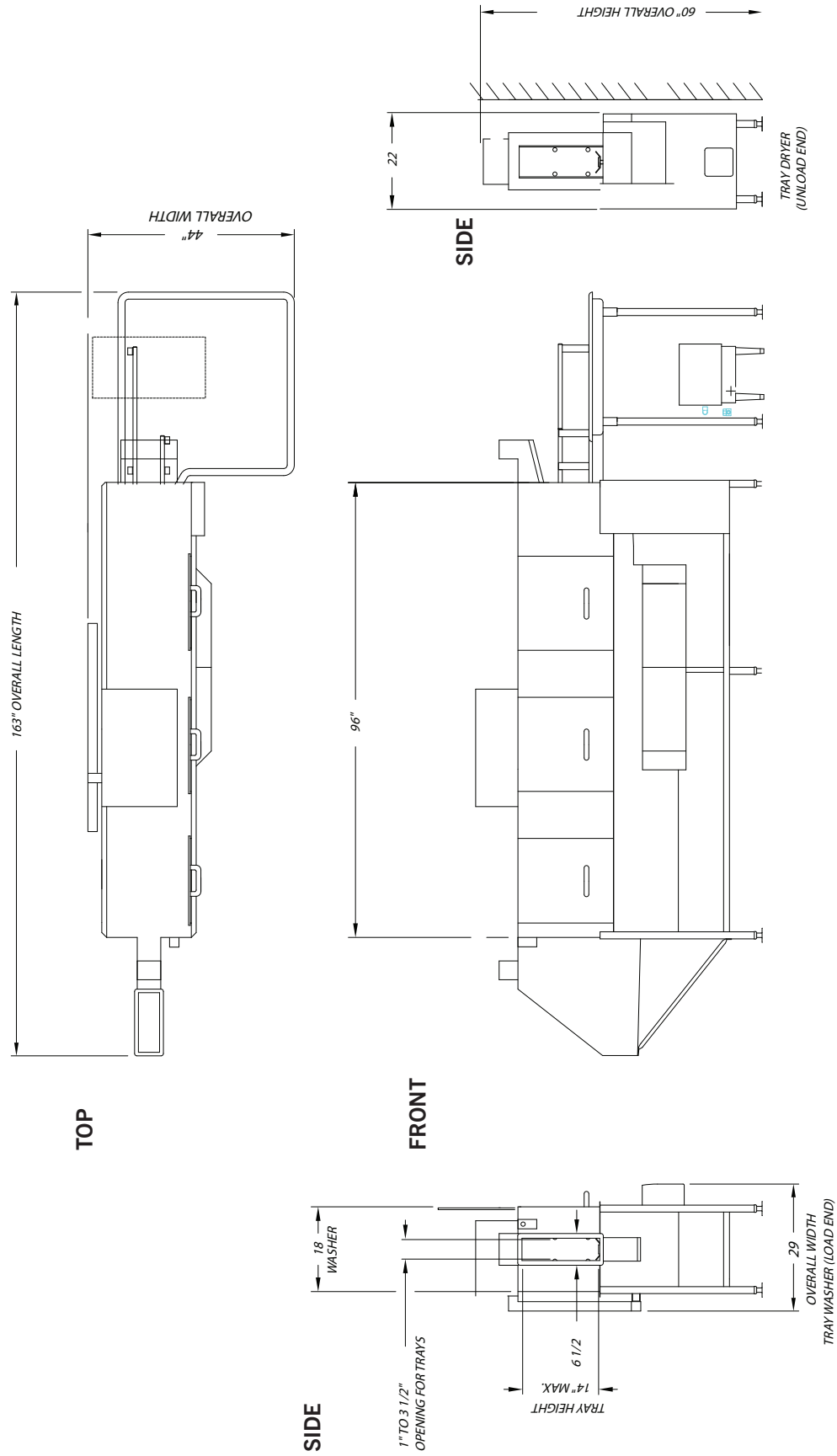

TECHNICAL INFORMATION

LEFT HAND FEED WITH TRAY DRYER, STACKER, AND ELECTRIC BOOSTER

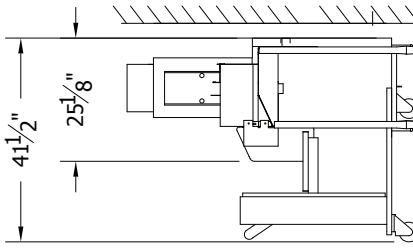
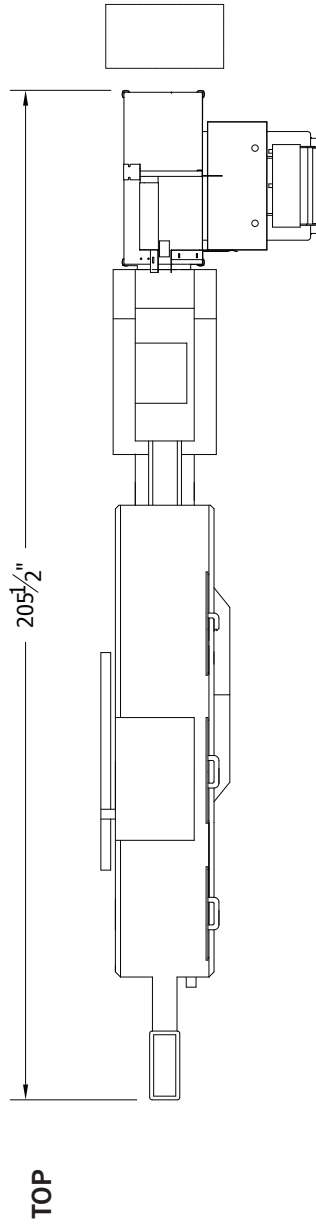

SIDE

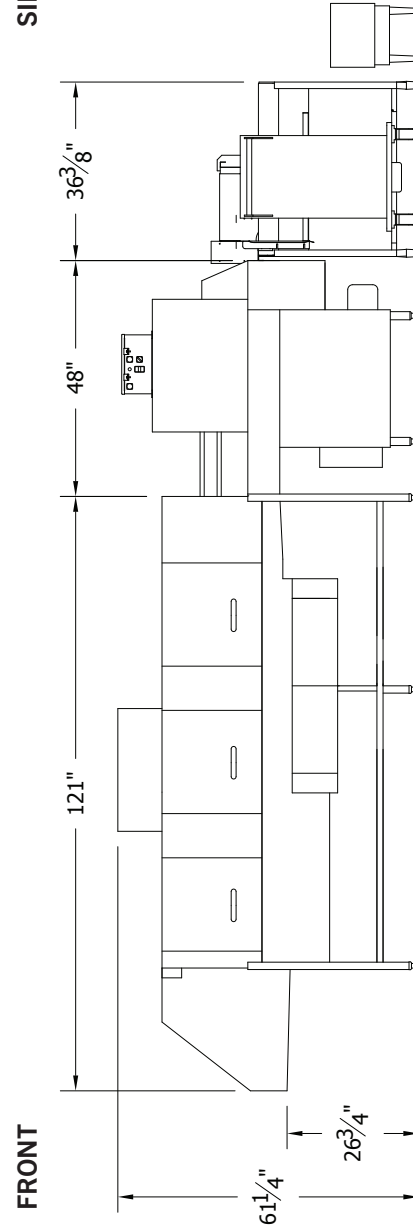

FRONT

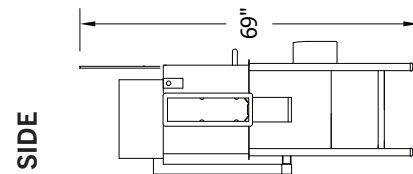

SIDE

TECHNICAL INFORMATION

RIGHT HAND FEED WITH TRAY DRYER, STACKER, AND ELECTRIC BOOSTER

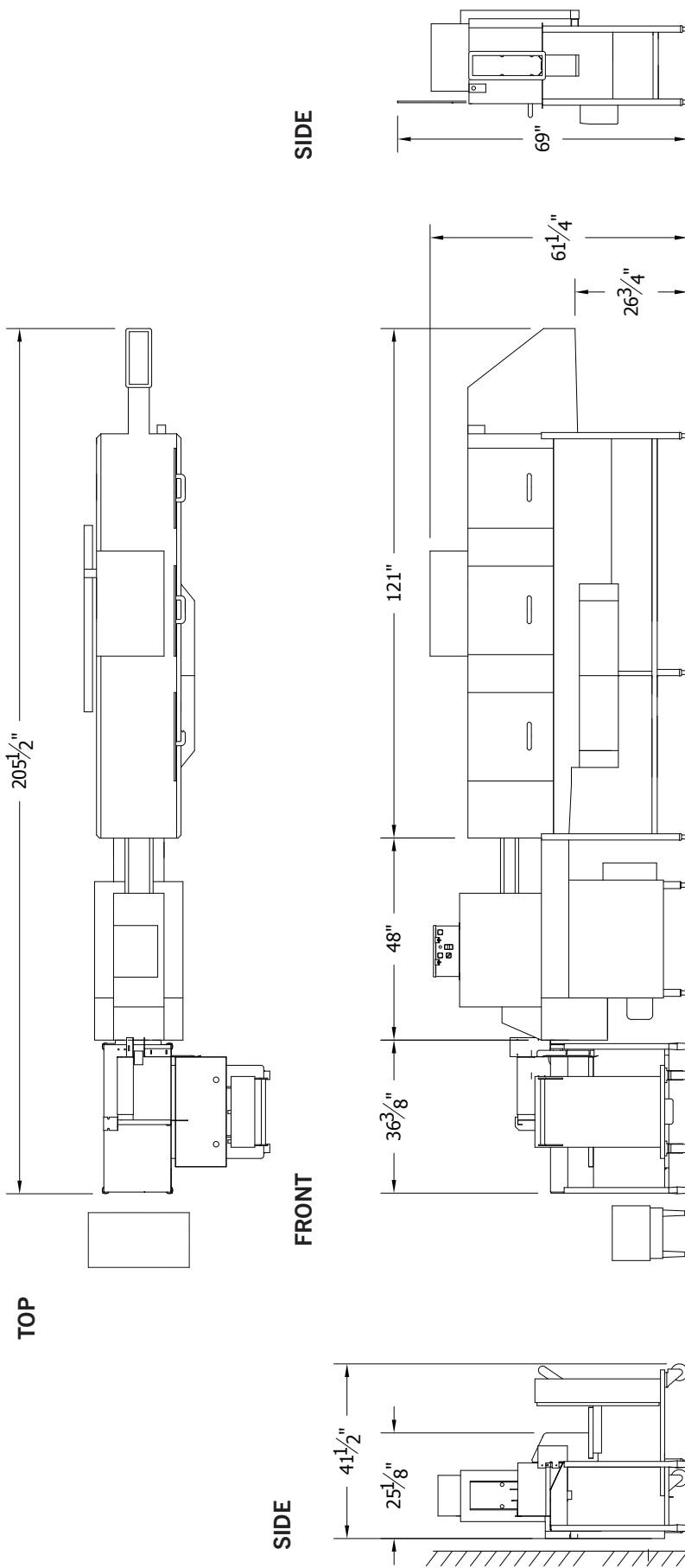

SPECIFICATIONS

Capacity	Trays Per Hour (15" tray)	878
Heating & Venting	Wash Tank Heat	8 kW
	Rinse Tank Heat	8 kW
	Booster Heat (40°F Rise)	24 kW
	Booster Heat (70°F Rise)	36 kW
	Venting (Load End)	100 CFM
	Venting (Unload End)	300 CFM
Water	Water Inlet Temperature	110°F
	Water Consumption (20 PSI)	197 gal/hr
	Final Rinse Peak Flow (20 PSI)	3.28 gal/min
	Pre-Wash Tank Capacity	11.2 gal
	Wash Tank Capacity	15.3 gal
	Rinse Tank Capacity	11.5 gal
	Peak Drain Flow	23 gal/min
Steam	Steam Tank Consumption (20 PSI)	54 lbs/hr
	Pre-Wash Motor	0.5 HP
Other	Drive Motor	1/8 HP
	Wash Motor	3 HP
	Rinse Motor	2 HP
	Shipping Weight	1,100

ELECTRICAL

	Service Options	TRAC 878 (Electric)	27 kW Booster	45 kW Booster
Electric Tank Heat	208/60/3	67.1 A	66.7 A	100 A
	240/60/3	59.0 A	57.8 A	86.7 A
	380/50/3	29.4 A	Contact Factory	
	480/60/3	36.9 A	28.9 A	43.4 A
	Service Options	TRAC 878 (Steam)		
Steam Tank Heat	208/60/3	22.7 A		
	240/60/3	20.6 A		
	380/50/3	10.2 A		
	480/60/3	12.5 A		

LEGEND

Type	Label	Description	Note
Water	W1	HOT WATER TO AUTO FILL - 110F	1/2 FIPS
	W2	HOT WATER TO FINAL RINSE - 180F	1/2 FIPS
	W3	HOT WATER TO STEAM BOOSTER - 110/140F	1/2 FIPS
	W4	HOT WATER TO ELECTRIC BOOSTER - 110/140F	1/2 FIPS
	D	DRAIN CONNECTION	1.5 FIPS
Electrical	E1	ELECTRIC SERVICE - WASH HEATERS & MOTORS	16 kW + 5.6 HP
	E2	ELECTRIC SERVICE - BOOSTER	24 or 36 kW
Steam	S1	STEAM TO TANKS	3/4 FIPS
	S2	STEAM TO BOOSTER	1/2 OR 1 FIPS
Other	R1	CONDENSATE RETURN - COILS	1/2 FIPS
	R2	CONDENSATE RETURN - BOOSTER	1/2 FIPS



Tray entering a TRAC 878.

Contact Insinger Sales at 800-344-4802 for an installation drawing specific to your application.

Note: Due to product improvement we reserve the right to change information and specifications without notice.