



**ADA Compliant**

*This Space for Architect/Engineer Approval*

Job Name \_\_\_\_\_ Date \_\_\_\_\_

Model Specified \_\_\_\_\_ Quantity \_\_\_\_\_

Customer/Wholesaler \_\_\_\_\_

Contractor \_\_\_\_\_

Architect/Engineer \_\_\_\_\_

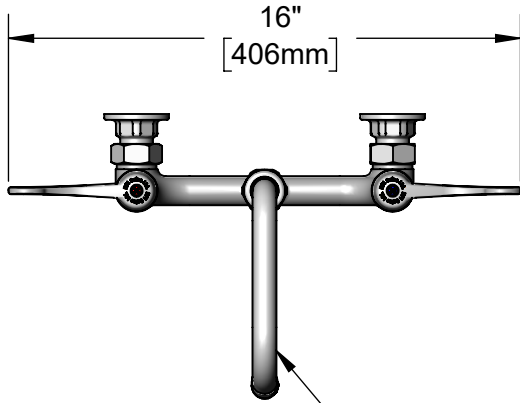

SIF-SN06A  
6" Swing Nozzle w/  
2.2 GPM Aerator

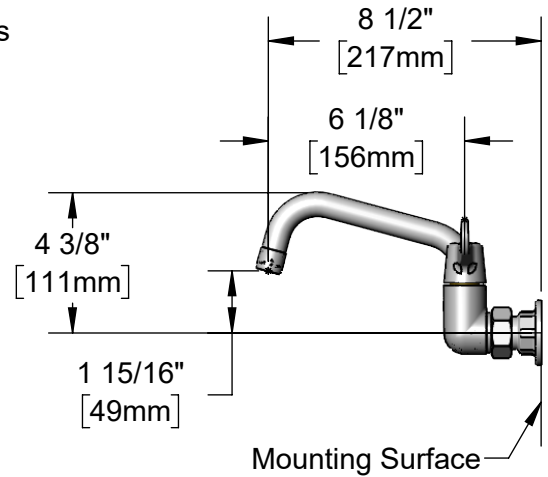
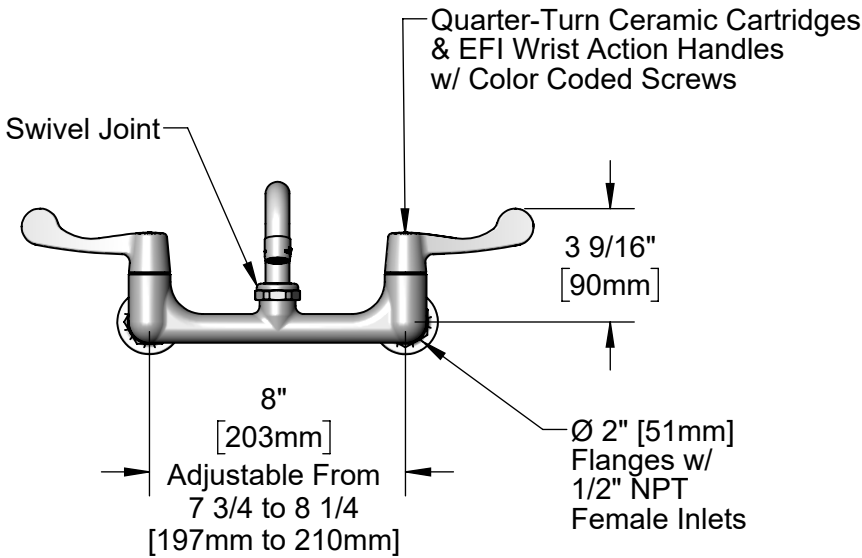
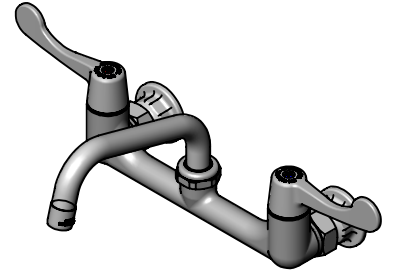

Model Number  
**SIF-F8WW06A**

Product Specifications:  
**8" Wall Mount Mixing Faucet, Quarter-Turn Ceramic Cartridges, EFI Wrist Action Handles, 6" Swing Nozzle w/ 2.2 GPM Aerator & 1/2" NPT Female Inlets**

Product Compliance:  
ASME A112.18.1 / CSA B125.1  
NSF 61 - Section 9  
NSF 372 (Low Lead Content)  
ANSI A117.1 (ADA)



26895 Gloucester Way  
Langley BC V4W 3Y3  
Toll Free: 1.888.565.9020  
Phone: 604.607.8850  
efifoodequip.com

ITEM NO.	SALES NO.	DESCRIPTION
1	SIF-SN06A	6" Swing Nozzle w/ 2.2 GPM Aerator
2	SIF-WA4	EFI Wrist Action Handle w/ Color Coded Screws
3	013788-45	Quarter-Turn Ceramic Cartridge, LTC
4	013787-45	Quarter-Turn Ceramic Cartridge, RTC

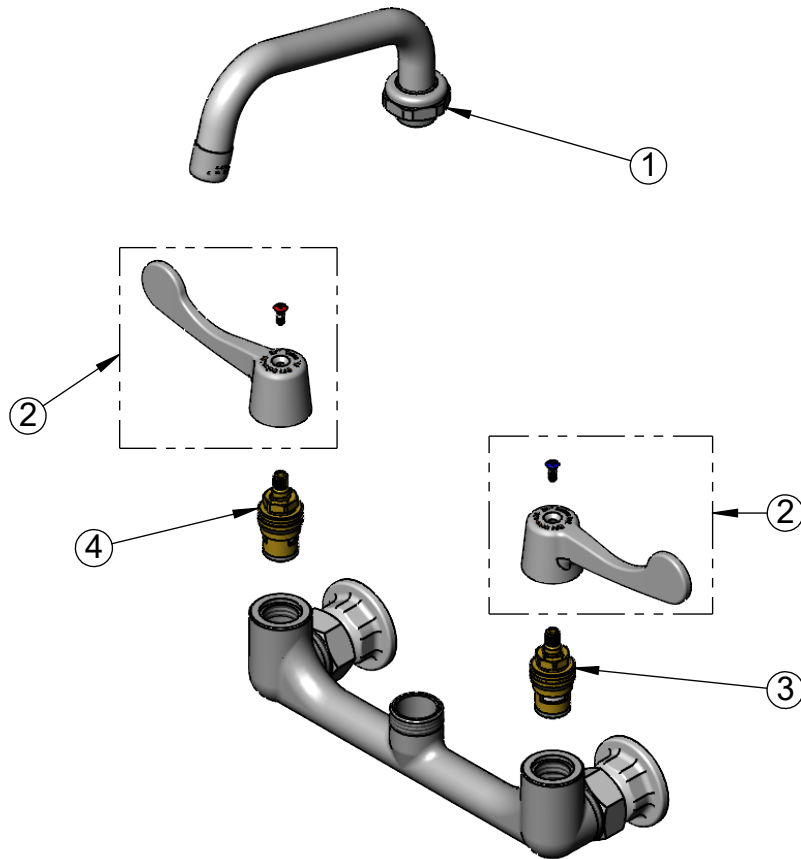

Model Number  
**SIF-F8WW06A**

Product Specifications:  
**8" Wall Mount Mixing Faucet, Quarter-Turn Ceramic Cartridges, EFI Wrist Action Handles, 6" Swing Nozzle w/ 2.2 GPM Aerator & 1/2" NPT Female Inlets**

Product Compliance:  
ASME A112.18.1 / CSA B125.1  
NSF 61 - Section 9  
NSF 372 (Low Lead Content)  
ANSI A117.1 (ADA)



26895 Gloucester Way  
Langley BC V4W 3Y3  
Toll Free: 1.888.565.9020  
Phone: 604.607.8850  
efifoodequip.com