



**Manufacturer**  
Brunner-Anliker



**Model**  
**XL Star**  
**Food Processing Machine**

High quality made in Switzerland. State-of-the-art materials and technology ensure highest reliability and precision for restaurants, catering, retirement and long term care, and any commercial kitchen that needs to save time and money in their food prep.

Specifications	
<b>Design</b>	<ul style="list-style-type: none"> <li>• Large kidney-shaped filler neck 2,100 cm<sup>3</sup></li> <li>• Rotating filler neck on the right for the cutting of Brunoises and Gaufrettes</li> <li>• Tool-free removal of top and plunger</li> <li>• Carry handle on the back</li> <li>• Electric cable 3 m long</li> <li>• Plunger made of fiberglass composite with antimicrobial effect</li> <li>• Cutting discs with a diameter of 240 mm (ceramics / PTFE coating)</li> <li>• Ceramics / PTFE coating, made entirely of noncorroding material</li> <li>• Extra protection by micro-fuse</li> <li>• Maintenance/service-free gear motor</li> </ul>
<b>Function</b>	Cutting, shredding, grating and grinding in up to 50 different ways
<b>Capacity</b>	Up to 300 Kg/h
<b>Voltage</b>	115 V, 60 Hz, (231.02510)
<b>Space requirements</b>	305 x 655 x 590 mm
<b>Noise</b>	40 dB
<b>Weight</b>	29.5 Kg
<b>Certificates</b>	CE, CSA, UL
<b>Design and dimensions (in mm)</b>	

## Accessories

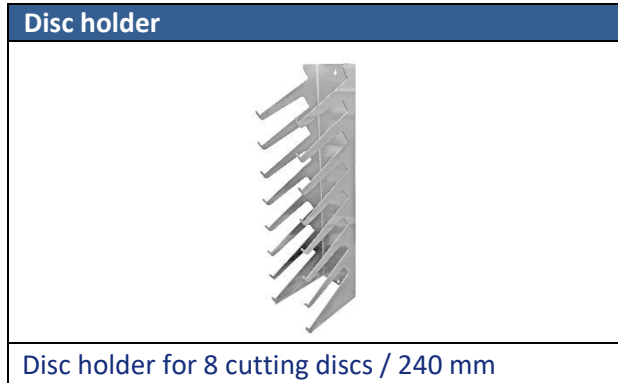



## Recommended standard disc set

Starter Kit (5 discs)	
Fine cut 1 mm	F1
Rough cut 3 mm	G3
Juliennes 2 mm	S2
Grating disc for hash browns	Nr. 0
Brunoises 3 mm	BR3

## Disc overview

	Slicing	Art. Nr.
Fine cut 1 mm	F1	232.02601
Fine cut 2 mm	F2	232.02602

	Juliennes	Art. Nr.
Juliennes 1.5 mm	S 1.5	232.02622
Juliennes 2 mm	S 2	232.02623
Juliennes 3 mm	S 3	232.02624

	Allumettes	Art. Nr
Allumettes 4 mm	PA 4	232.02631
Allumettes 5 mm	PA 5	232.02633
Allumettes 6 mm	WS	232.02240

	Slicing	Art. Nr.
Rough cut 3 mm	G3	232.02603
Rough cut 4 mm	G4	232.02288
Rough cut 6 mm	G6	232.02606
Rough cut 8 mm	G8	232.02236
Rough cut 10 mm	G10	232.02237
Rough cut 12 mm	G12	232.02238
Rough cut 16 mm	G16	232.02552

	Sickle blade	Art. Nr.
Sickle knife 1.5 mm	SM 1.5	232.02675
Sickle knife 2.5 mm	SM 2.5	232.02676
Sickle knife 4.5 mm	SM 4.5	232.02678

	Brunoises	Art. Nr.
Brunoises 3 mm	BR 3	232.02639
Brunoises 4 mm	BR 4	232.02640
Brunoises 5 mm	BR 5	232.02641

	Bâtonnets	Art. Nr.
Bâtonnets 6 mm	BT 6	232.02241
Bâtonnets 7 mm	BT 7	232.02242
Bâtonnets 8 mm	BT 8	232.02243
Bâtonnets 10 mm	BT 10	232.02244

	Wavy cut	Art. Nr.
Wavy cut 5 mm	SU 5	232.02298
Wavy cut 7 mm	SU 7	232.02258

	Dicing	Art. Nr.
Cubes 6 mm	W 6	232.02245
Cubes 8 mm	W 8	232.02247
Cubes 10 mm	W 10	232.02248
Cubes 14 mm	W 14	232.02250

	Cubes WK	Art. Nr.
Body for WK	WK-BODY-7	232.02252
Cubing knife WK	WK-CUBING KNIFE-7	232.02506
Grid 8 mm	WK 8	232.02254
Grid 10 mm	WK 10	232.02255
Grid 14 mm	WK 14	232.02256
Grid 24 mm	WK 24	232.02257

	Shredding	Art. Nr.
Shredding 13 mm	No 000	232.02259
Shredding 11 mm	No. 00	232.02260
Shredding 9 mm	No. 0	232.02700
Shredding 7 mm	No. 1	232.02701
Shredding 6 mm	No. 2	232.02702
Shredding 5 mm	No. 3	232.02551
Shredding 4.2 mm	No. 4	232.02265
Shredding 3 mm	No. 7	232.02266
Shredding 2.5 mm	No. 9	232.02267
Shredding 2 mm	No. 11	232.02268
Shredding 1.8 mm	No. 12	232.02712
Grating-Parmesan	No. 14	232.02270
Fondue 12 mm	No. 18	232.02718
Fondue 16 mm	No. 19	232.02719
Universal 2.5 mm	No. 23	232.02723

	Tomato cut	Art. Nr.
Tomato cut 5 mm	TO	232.02614

	Shaving cut	Art. Nr.
Shaving cut 0.5mm	HS	232.02621

	Gaufrettes	Art. Nr.
Gaufrettes 4 mm	PG 4	232.02286
Gaufrettes 8 mm	PG 8	232.02293