



223 W Rosecrans Ave., Gardena, CA 90248
T. 310-808-0102 www.blueairfse.com

Project:	
Location:	
Item #:	
Model #:	Qty:
AIA #:	SIS #:
CSI Section 11400	

Back Bar Cooler - Narrow Depth / Glass Door

Model
BLNBB-48BG-HC

Model

BLNBB-48BG-HC



Cabinet Construction

- Stainless steel top with black powder-coated steel exterior and stainless steel interior
- High-density, foamed-in-place polyurethane insulation – environmentally friendly
- Two (2) adjustable shelves per section
- Interior height allows stacking of three “tall boy” beers
- Four (4) 4” diameter swivel casters with front brakes standard

Refrigeration

- Front-breathing, side-mounted compressor for efficient operation in tight spaces and easy service access
- Forced-air cooling system maintains consistent temperature throughout the cabinet for reliable performance
- Automatic defrost system minimizes maintenance and ensures stable operation

Hydrocarbon refrigerants (R-290)

- Hydrocarbon refrigerant (R-290) increases energy efficiency and does not deplete the ozone layer.

Doors

- Double-pane glass doors with black frames
- Vertical door handles for easy access
- Durable door gaskets with easy replacement
- Standard door locks

Design & Features

- LED interior lighting for enhanced product visibility
- Digital temperature control with real-time monitoring
- Optimized airflow for consistent cooling performance
- Maintains cabinet temperatures of 34°F to 38°F for optimal beverage preservation



Model	Doors	Shelves	Capacity (Cu.ft.)	HP	AMPS	W x D x H [†] (inches)	Crated Weight (lbs.)
BLNBB-48BG-HC	2	4	11.6	1/3	3.0	49 ¹ / ₈ x 24 ³ / ₈ x 36 ¹ / ₄	288

Back Bar Cooler - Narrow Depth / Glass Door

PLAN VIEW

(Unit: inches)

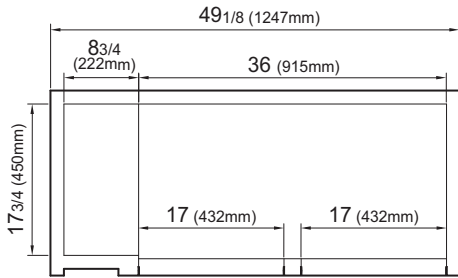

TOP VIEW

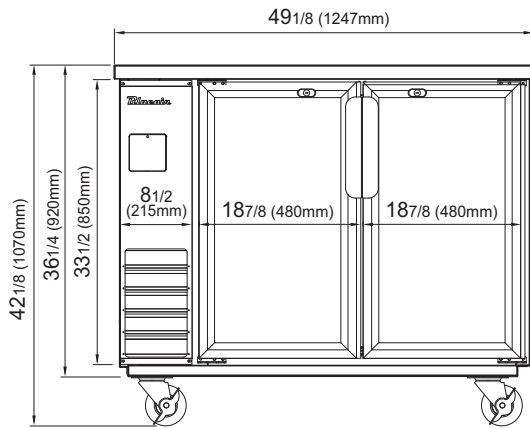

FRONT VIEW

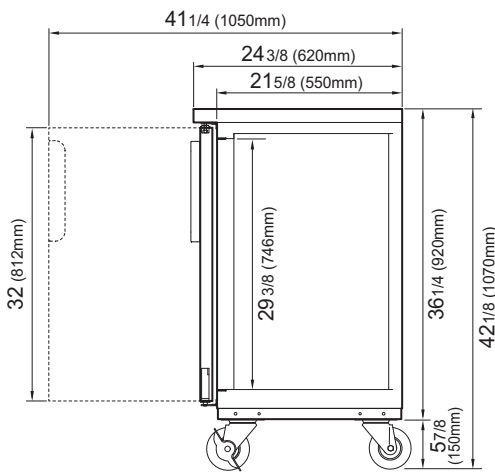

SIDE VIEW

Model

BLNBB-48BG-HC

Voltage	115V/60Hz
NEMA Config.	 NEMA 5-15P
AMPS	3.0
HP	1/3
Cord Length (ft.)	9.2
Refrigerant	R-290
Ext. Width (inches)(mm)	49 1/8 (1247mm)
Ext. Depth (inches)(mm)	24 3/8 (620mm)
Ext. Height (inches)(mm)†	36 1/4 (920mm)
Doors	2
Shelves	4
Net Capacity (cu. ft.)	11.6
6-pack of 12 oz Bottles	36
6-pack of 12 oz Cans	72
Net Weight	251 lbs. (114 kg)
Gross Weight	288 lbs. (131 kg)

Specifications subject to change without notice.
† Height does not include 5-7/8" for caster height.

Warranty



3 Year Parts and Labor Warranty
5 Year Compressor Warranty

Standard Features

- Four (4) 4" diameter casters with front brakes
- Door locks
- Self-contained system



223 W Rosecrans Ave., Gardena, CA 90248
T. 310-808-0102

 blueairfse.com
 orders@blueairfse.com